

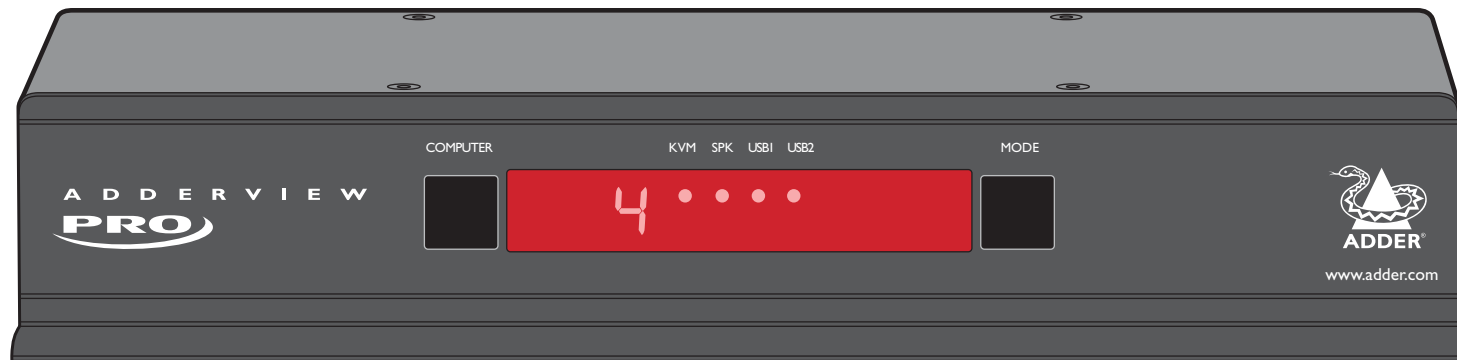

# AV4PRO-DVI

## User Guide

- AV4PRO-DVI
- AV4PRO-DVI-DUAL
- AV4PRO-DVI-TRIPLE
- AV4PRO-DVI-QUAD



[CONTENTS](#)

# Contents



## Introduction

What is True Emulation?.....	3
AV4PRO-DVI features - front and rear.....	4
What's in the box .....	5
What you may additionally need .....	5

## Installation

Mounting .....	6
Connections .....	7
User console .....	7
Computer systems.....	8
Power in connection.....	9
Optional RC4 remote control.....	9
Channel switching by external control .....	10
Synchronising multiple units.....	11
Managing EDID video display information.....	12
Hybrid DDC (support for DDC/CI) .....	12

## Configuration

Using the configuration menu .....	13
General configuration.....	14
Changing hotkeys.....	14
Mouse switching .....	14
OPTIONS port speed .....	14
OPTIONS port channel control behaviour .....	14
Switching mode .....	15
Miscellaneous functions .....	15
Performing upgrades .....	16

## Operation

Selecting a computer.....	18
To select a computer using the front panel .....	18
To select a computer using hotkeys .....	19
To select a computer using the mouse buttons.....	20
To lock access to the computers .....	21
Autoscanning.....	22

## Further information

Getting assistance.....	23
Appendix 1 – Default EDID video modes.....	24
Appendix 2 – Cable pin-outs.....	25

## Index

INSTALLATION

CONFIGURATION

OPERATION

FURTHER INFORMATION

INDEX

# Introduction



Thank you for choosing a member of the AdderView Pro (AV4PRO) family of professional switches from Adder Technology. There are four versions of the AV4PRO-DVI, each of which allows a single operator to control up to four computer systems and share peripherals among them in a very flexible manner. The AV4PRO-DVI can support one video head per channel, whereas the slightly larger AV4PRO-DVI-DUAL, AV4PRO-DVI-TRIPLE and AV4PRO-DVI-QUAD units support two, three and four video heads per channel, respectively.

Thanks to our high quality, efficient switching technology, each video head can support dual link digital video at up to 450Mpixels per second. In addition to the impressive video performance, these units offer more than just straight switching between four systems. The KVM, speakers and two separate USB devices attached to the AV4PRO-DVI units can either be switched in unison, as normal, or you can mix your peripherals between any of the systems to suit your current tasks. For instance, you could be creating emails

on one system, listening to a soundtrack from another while a third is sending documents to your printer and a fourth performing another task with a different USB peripheral. The AV4PRO-DVI front panels make it straightforward to control which peripherals should connect to each system.

The AV4PRO-DVI units feature [True Emulation](#) which ensures that the full characteristics of the connected keyboard and mouse are passed to every system.

**Multiscreen versions**  
The AV4PRO-DVI range includes separate models to support one, two, three or four video heads per channel.

**Digital and analogue video**  
The AV4PRO-DVI units use DVI-I (Integrated) connectors throughout so that DVI digital and/or VGA analogue video may be used (the latter requires the use of suitable adapter cables).

**Intelligent display information**  
The AV4PRO-DVI units use our [EDID Emulation](#) feature to ensure that all computers are supplied with the correct information about each connected video display.

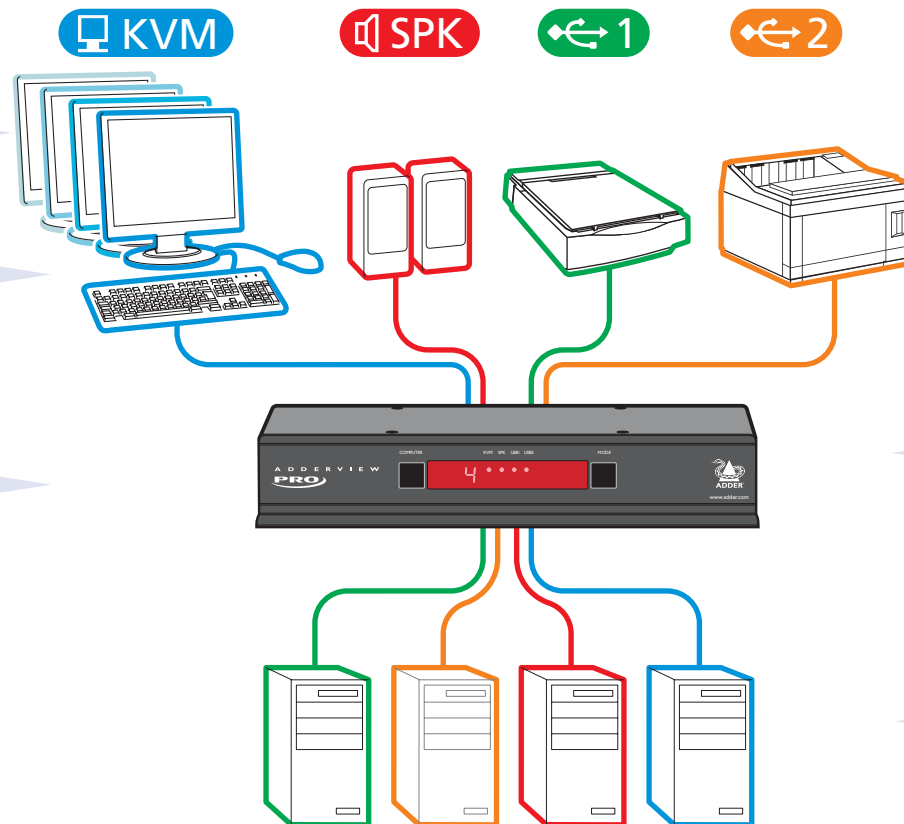

**Multiple switching**  
The attached peripheral devices can be switched collectively to any computer system, or can be linked to separate systems to achieve multiple tasks in parallel. Multiple switching can be controlled from the on-screen menu or using the front panel buttons.

**True Emulation**  
Earlier USB KVM switches relied upon standard keyboard and mouse templates to inform each computer system how to deal with the connected peripherals. The AV4PRO-DVI range succeeds in harvesting the true identities of the connected keyboard and mouse and presents those 'real' profiles concurrently to every system. Thus, specialist keyboards and mice can be fully supported.

**USB Remote wakeup**  
The USB Remote Wakeup feature is fully supported. Any connected computer can go into sleep mode and be awakened (when its channel is selected) as soon as you press a key or move the mouse. The computer and peripherals must support the USB Remote Wakeup feature.

INSTALLATION

CONFIGURATION

OPERATION

FURTHER INFORMATION

INDEX

# What is True Emulation?

True Emulation represents a significant breakthrough in sharing USB devices between two or more computer systems. Until this point, the problem has been how to create a USB switch that provides all of the following:

- Quick, transparent and reliable switching,
- Accurate representation of the connected USB keyboard and mouse,
- Switching control via the connected USB keyboard and/or mouse.

The difficulty in achieving all of the above requirements has been due to the complexity of the USB standard. This has led to various problems that have spawned a number of possible solutions.

## Enumerated USB switching

The earliest attempts to switch USB devices applied a relatively 'hands off' approach. Enumerated USB switches are the electronic equivalent of those old mechanical KVM switches with a large knob on the front.

Enumerated switches are so called because a connected USB device will be required to perform a full initiation (a process called *Enumeration*) every time it is switched; just as if you had pulled out the plug and then reconnected it.

Enumerated switches simply pass all signals straight through between the USB device and the computer, they do not attempt to interpret any data. For most devices, this offers an advantage because the switch just leaves them to get on with their jobs without any interference or any hit on performance. However, it means that a USB keyboard or mouse cannot be used to control the switching process - a quick and simple control method expected by most users. Reliability of switching is also an issue that has plagued enumerated switches, especially when used with certain USB devices and particular operating systems.

## Emulated USB switching

The issues with interpreting the complex USB data streams and recreating (or *Emulating*) the identity of attached USB devices were eventually solved, leading to the creation of the Emulated USB switch.

A neat side effect of the technique used is that each computer can be fooled into thinking that the USB device is permanently connected to it, even when the device is switched to another computer. This means that the enumeration process for the USB device takes place only once, during the first power on. After that, a computer merely sees a dormant version of the USB device whenever the device is actually connected to a different computer.

However, it remains a complex task to dynamically assume the identity of a USB device, distribute it among the connected computers and maintain all of the necessary signals, states and processes. Therefore, manufacturers have previously relied upon a fixed keyboard and mouse profile that is declared to each computer, regardless of the actual connected devices. This precluded the use of any special keyboard or mouse features over and above the standard layouts.

## True Emulation

Mindful of the limitations associated with the previous USB switching techniques, we set about creating a more effective and elegant solution. After a great deal of research and development, *True Emulation* is the result.

True Emulation allows the complete identity of the keyboard and mouse to be copied and then presented to all of the connected computers. This means that any keyboard offering specialist function keys or any mouse with extra features will be fully supported at each computer. As with the previous emulation method, the unselected computers will continue to see the identities of the keyboard and mouse, which means that no enumeration is necessary when their link becomes active once again. This not only helps to speed up the rate of reconnection, but also raises the reliability of switching because USB links are at their most vulnerable during the enumeration process.

True Emulation relies upon a high speed circuit, called an Emulation Engine, to fully emulate the USB device identities and also interpret keyboard and mouse data streams. The result is full support for KVM switching control via hotkey presses or the third button/scroll wheel of a mouse.

True Emulation is not necessarily required by other USB devices, which is why you will also find two enumerated circuits included (shown in green within the block diagram) alongside the True Emulation feature (shown in blue). This allows those other USB devices to operate at their highest speeds, without any intervention. The enumerated circuits benefit greatly from the USB Hubs that are jointly used with the True Emulation system. Because they interface directly and permanently with each computer, they help to stabilise the dormant links, making errors during enumeration much less likely.

The dual switching arrangement provides further flexibility because the True Emulation and enumerated sections can be switched in unison or independently of each other, as required. Thus, your various peripherals can operate with different computers at the same time.

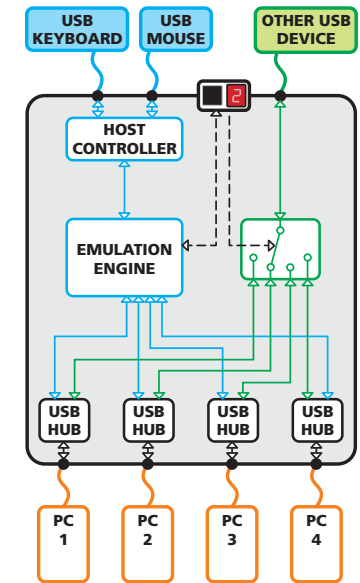

The emulated section of the switch is shown in blue and handles only the keyboard and mouse. The green enumerated section of the switch handles other USB devices and also uses the USB hubs to link with the computers.



- INSTALLATION
- CONFIGURATION
- OPERATION
- FURTHER INFORMATION
- INDEX

# AV4PRO-DVI features - front and rear

The AV4PRO-DVI single screen and multiscreen units are housed within durable, metallic enclosures with all connectors situated at the rear panel. The smart front face features the control buttons and the operation indicators.

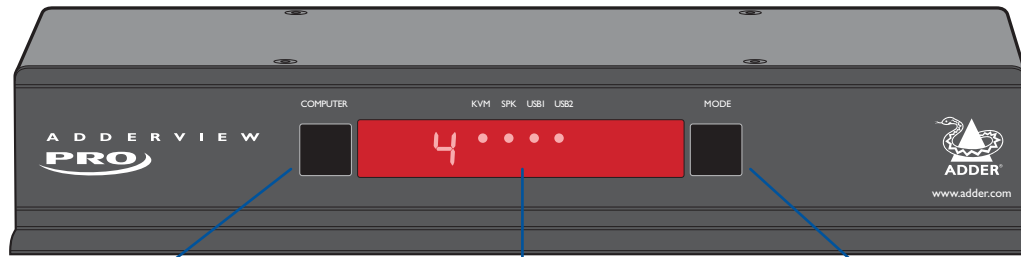

### COMPUTER button

Press to change to the next computer channel.

### Indicators

The four indicators (**KVM**, **SPK**, **USB1**, **USB2**) show which peripherals are switched to the current computer channel OR (as you begin pressing the **MODE** button) the peripherals that will be switched during the next press(es) of the **COMPUTER** button.

The seven segment numeric display indicates the computer channel that is currently active.

### MODE button

Press to determine which peripherals should be switched to another computer channel (will occur when the **COMPUTER** button is pressed).

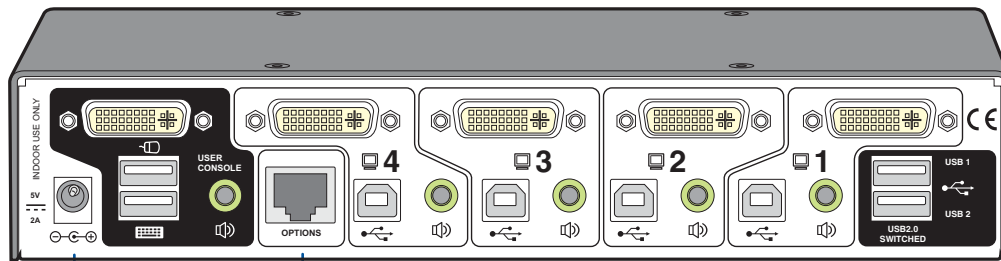

### Power input

The power supply connects here.

### User console

Connect DVI-I video, USB keyboard and mouse plus optional speakers to these connectors.

### Options port

This 10p10c port can separately support the following functions:

- Remote control - allows a standard Adder RC4 four button remote control unit to be used to switch channels (see [Optional RC4 remote control](#) for details).
- Upgrades - used to update the internal firmware when necessary by connecting to a computer.

### Computer channels

Each computer connects to one of these four channels via a DVI-I video connector, a USB B-type connector and an audio 3.5mm jack input.

### User console

Connect up to two USB devices to these connectors. These ports are switched in an enumerated manner (see [What is True Emulation?](#))



## Multiscreen versions

The Dual, Triple and Quad video screen versions use a larger casing and provide more connectors on the rear panel.

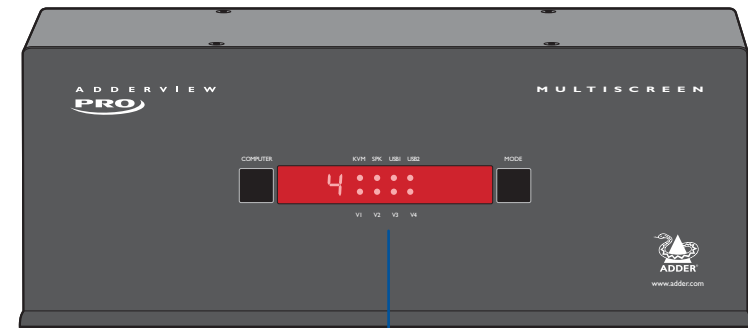

### Extra indicators

As well as the indicators shown on the single screen version, the multiscreen units also include four indicators, labelled V1 to V4, which show the video channels being switched.

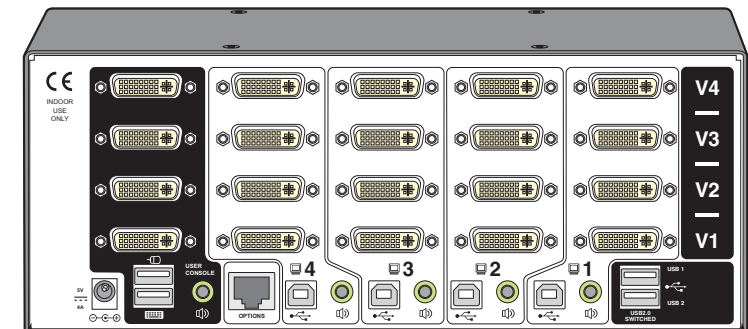

### Extra video channels

In addition to all of the ports described (left) for the single screen version, the multiscreen versions provide additional DVI-I connectors to allow multiple video streams from each computer to be switched to (up to) four video monitors.

INSTALLATION

CONFIGURATION

OPERATION

FURTHER INFORMATION

INDEX

# What's in the box

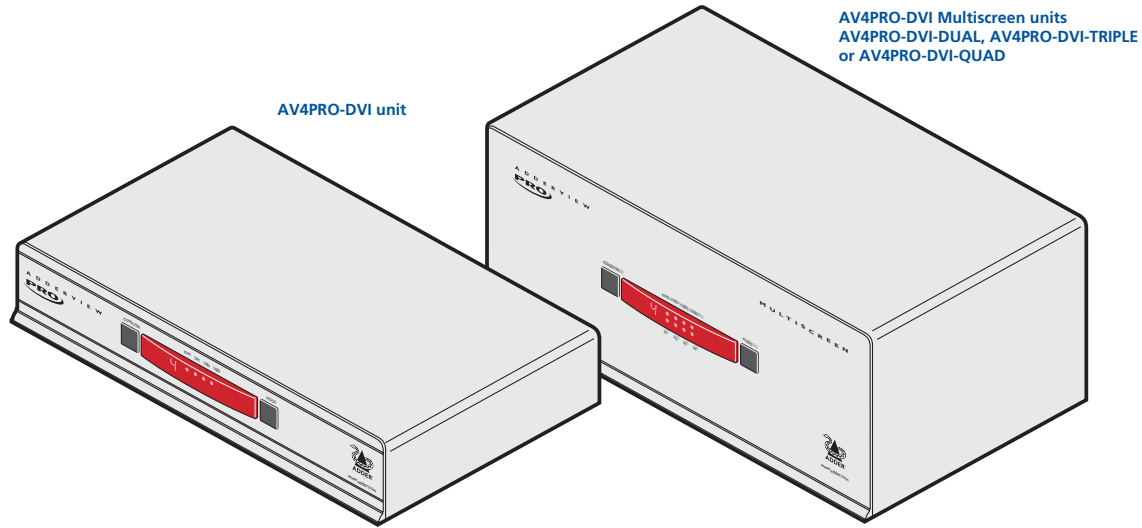

AV4PRO-DVI unit

AV4PRO-DVI Multiscreen units  
AV4PRO-DVI-DUAL, AV4PRO-DVI-TRIPLE  
or AV4PRO-DVI-QUAD

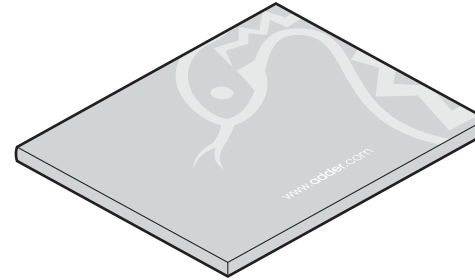

Information wallet  
containing:  
Four self-adhesive rubber feet  
Safety document

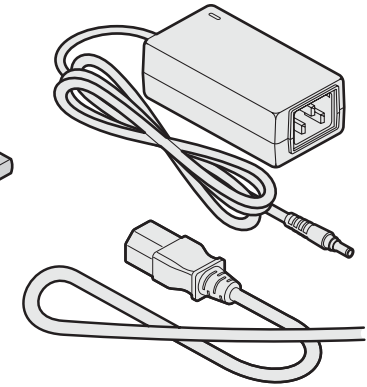

Power adapter (12.5W or 20W)  
and country-specific power lead

# What you may additionally need

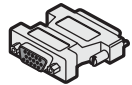

DVI to VGA adaptor  
Part number: VSA11

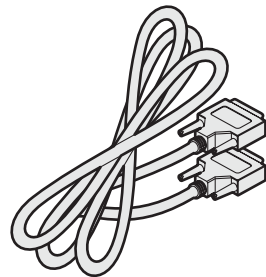

Single link DVI-D to DVI-D video cable  
Part number: VSCD1

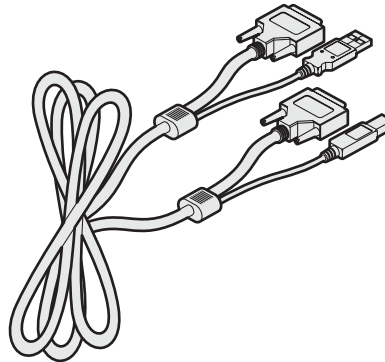

Combined dual link DVI-D and USB (USB type A to B) cable  
Part numbers: VSCD3 (2m length)  
VSCD4 (5m length)

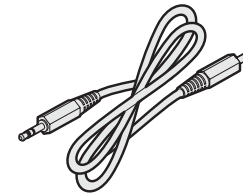

Audio cable 2m (3.5mm stereo jacks)  
Part number: VSC22

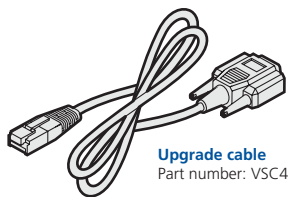

Upgrade cable  
Part number: VSC40

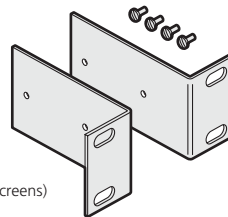

Two 19" rack-mount brackets  
and screws  
Part numbers:  
RMK3 (single screen)  
RMK5PRO-MS (dual, triple & quad screens)

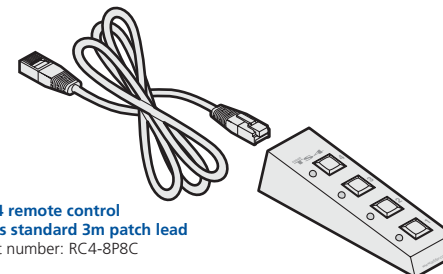

RC4 remote control  
plus standard 3m patch lead  
Part number: RC4-8P8C

- INSTALLATION
- CONFIGURATION
- OPERATION
- FURTHER INFORMATION
- INDEX

# Installation

## Mounting

There are two main mounting methods:

- The supplied four self-adhesive rubber feet
- Optional rack brackets (AV4PRO-DVI models only)

## Connections

*Note: Both the AV4PRO-DVI unit and its power supply generate heat when in operation and will become warm to the touch. Do not enclose them or place them in locations where air cannot circulate to cool the equipment. Do not operate the equipment in ambient temperatures exceeding 40 degrees Centigrade. Do not place the products in contact with equipment whose surface temperature exceeds 40 degrees Centigrade.*

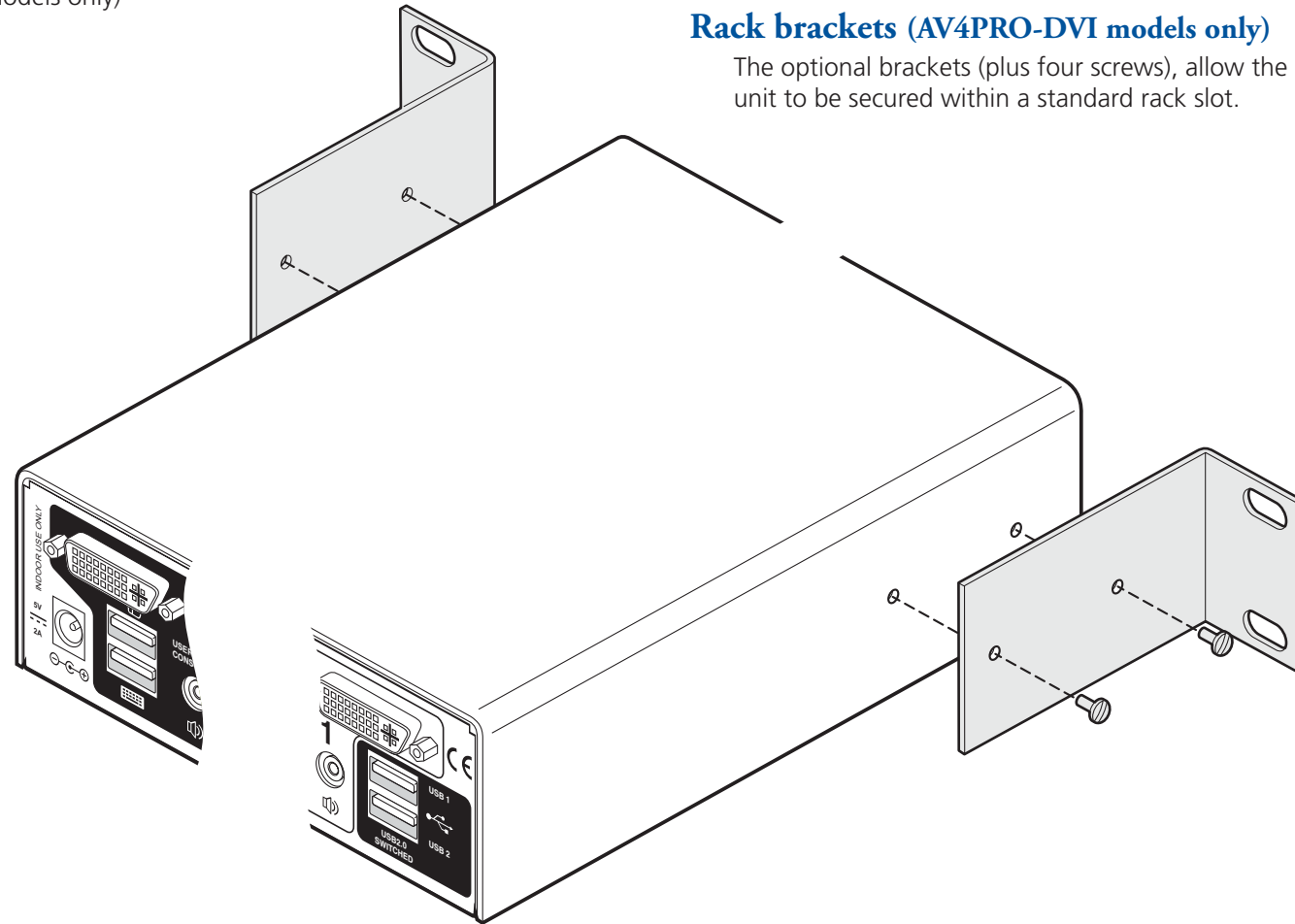

## Rack brackets (AV4PRO-DVI models only)

The optional brackets (plus four screws), allow the unit to be secured within a standard rack slot.

# Connections

Connections do not need to be carried out in the order given within this guide, however, where possible connect the *power in* as a final step.

## User console

The ports that make up the user console are where you attach the peripherals that will be shared between the computer systems. Ensure that power is disconnected from the unit.

### To connect peripherals to the user console

- 1 Position your peripheral devices in the vicinity of the unit such that their cables will easily reach.
- 2 **Keyboard and mouse:** Attach the leads from your USB keyboard and mouse to the USB sockets specifically labelled with keyboard and mouse symbols. The keyboard and mouse will operate in any of the USB sockets, however, **True Emulation** is not available on sockets labelled USB1 or USB2.

*Note: The unit's True Emulation feature will read the full characteristics of the keyboard and mouse and will present those to each connected computer concurrently. This ensures that specialist keyboards and mice are fully supported.*

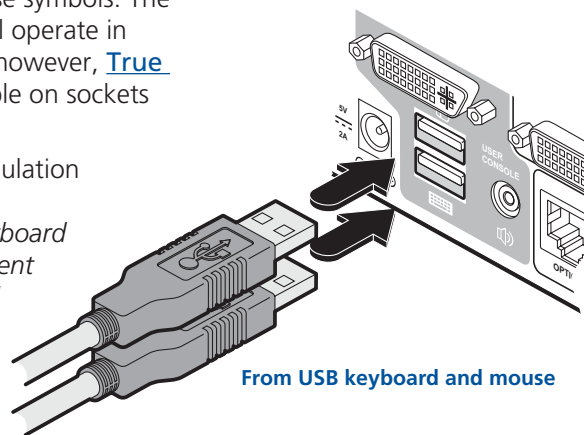

- 3 **USB devices:** Where required, attach the leads from your USB peripherals to the USB sockets labelled USB1 and USB2.

*Note: These sockets provide **enumerated** (transparent) switching.*

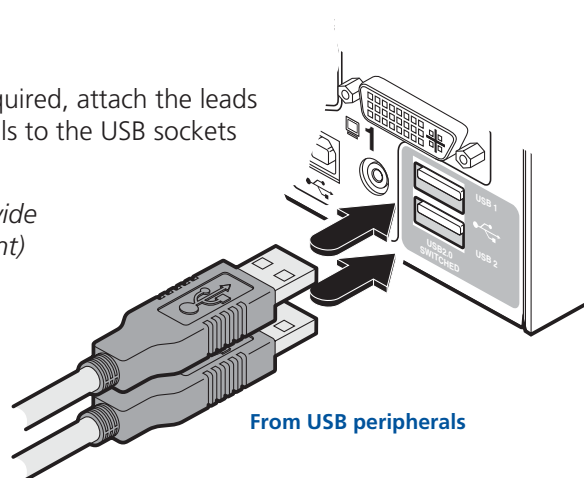

- 4 **Video monitor(s):** DVI-I (integrated) video ports are used throughout to allow digital DVI and/or VGA analogue (via adapter cables) signals to be switched, as required.

*Single screen units:* Attach the lead from the video monitor to the DVI-I connector of the user console area.

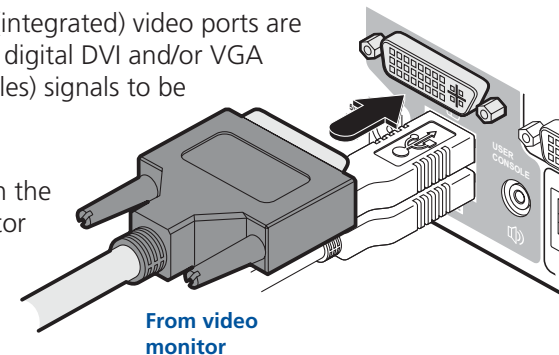

During initial power up, the AV4PRO-DVI unit will attempt to read the EDID information from the connected display(s). See [Managing EDID video display information](#) for details.

*Multiscreen units:* Attach the lead from each video monitor to a DVI-I connector of the user console area.

*Note: On the rear panel of the unit, the connectors at each horizontal level (V1 to V4) will be switched through to the user console DVI-I connector which is at the same level.*

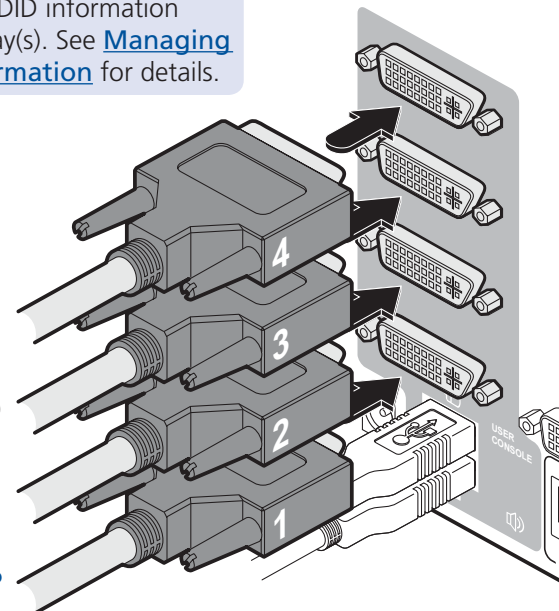

- 5 **Audio:** Where required, connect the lead from your speakers to the audio socket.

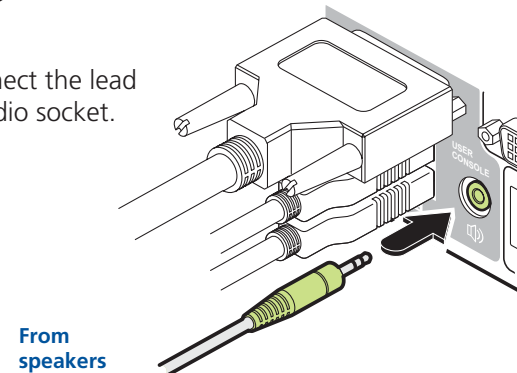



## Computer systems

Each computer system is connected to the AV4PRO-DVI unit using up to three cables.

### To connect a computer system

- 1 Ensure that power is disconnected from the AV4PRO-DVI unit and the system to be connected.
- 2 Use a USB cable (type-A to type-B) to link a USB port on the computer system to the USB port of the required channel on the rear of the unit.
- 3 If required, use a stereo audio link cable (3.5mm jacks at either end) to link the speaker port on the computer system to the audio port of the required channel on the rear of the unit.

From the USB port on the computer

From the speaker port on the computer

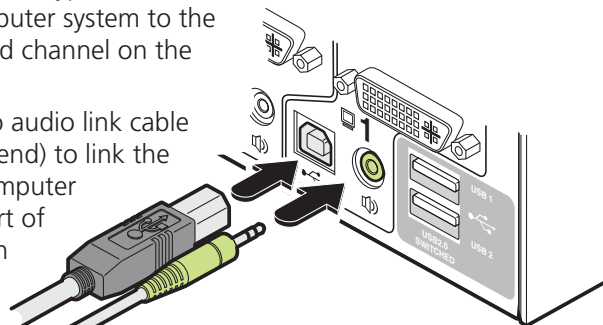

- 4 *Single screen units:* Use a DVI cable or a VGA to DVI-I adapter cable (if using analogue signals) to link the video output of the computer's graphic port to the DVI-I port of the required channel on the rear of the unit.

*Note:* A combined DVI-D and USB (type A to B) cable is also available for linking computers to the AV4PRO-DVI unit (Part numbers: VSCD3 for a 2m cable and VSCD4 for a 5m cable).

From the video port on the computer

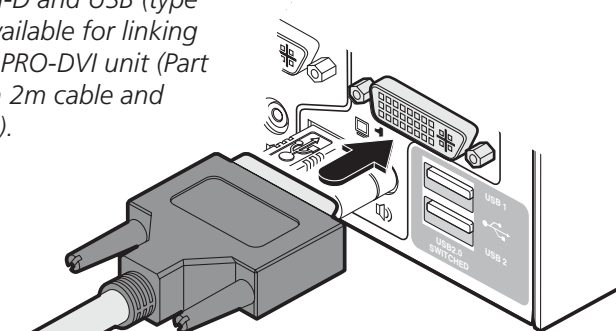

During initial power up, the AV4PRO-DVI unit will attempt to read the EDID information from the connected display(s). See [Managing EDID video display information](#) for details.

*Multiscreen units:* Use DVI or VGA to DVI-I adapter cables (if using analogue signals) to link the video outputs of each computer to the DVI-I ports on the rear of the unit (see note below).

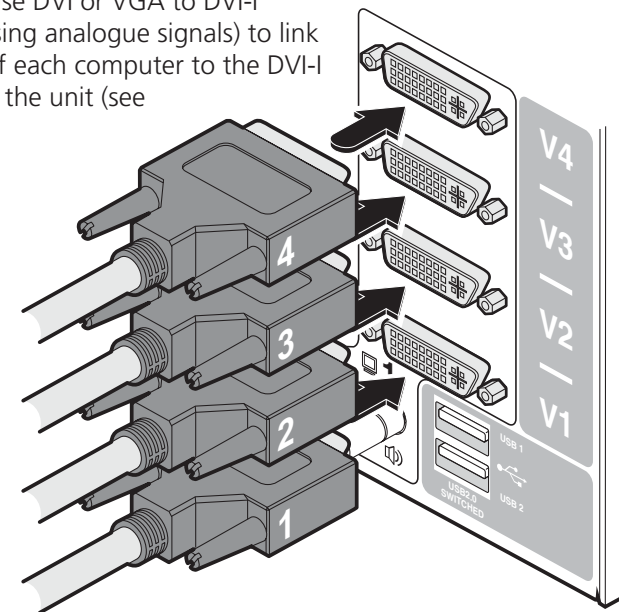

*Note:* On the rear panel of the unit, connectors belonging to the same channel are stacked vertically. The connectors at each horizontal level (V1 to V4) will be switched through to the user console DVI-I connector which is at the same level:

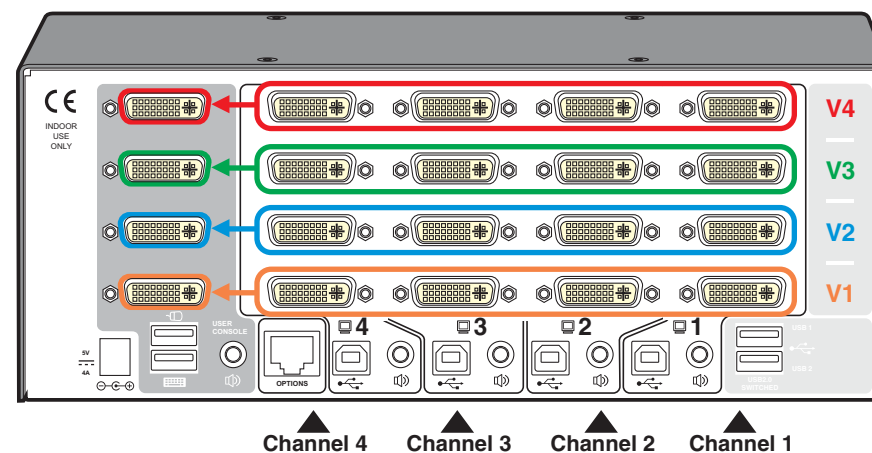

## Power in connection

The AV4PRO-DVI unit is supplied with either a 12.5W (single screen version) or 20W (Multiscreen versions) power adapter. There is no on/off switch on the unit, so operation begins as soon as a power adapter is connected.

### To connect the power supply

- 1 Attach the output lead from the power adapter to the 5V socket on the rear panel of the unit.

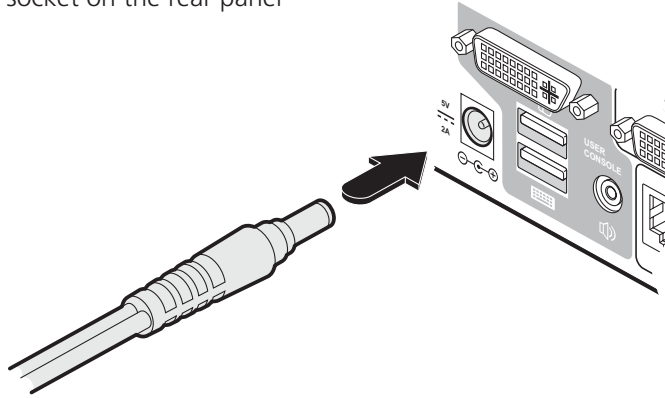

- 2 Connect the IEC connector of the supplied country-specific power lead to the socket of the power adapter.

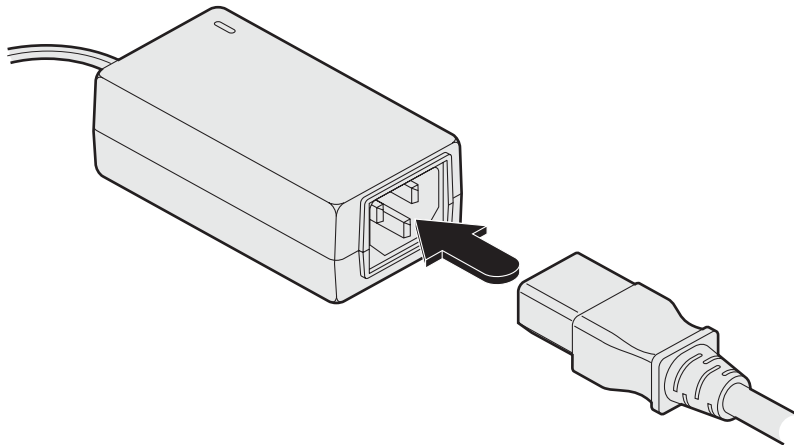

- 3 Connect the power lead to a nearby main supply socket.

*Note: Both the unit and its power supply generate heat when in operation and will become warm to the touch. Do not enclose them or place them in locations where air cannot circulate to cool the equipment. Do not operate the equipment in ambient temperatures exceeding 40 degrees Centigrade. Do not place the products in contact with equipment whose surface temperature exceeds 40 degrees Centigrade.*

## Optional RC4 remote control

The optional RC4 remote control unit (full part number: RC4-8P8C) can be used to provide direct push button access to any channel from your desktop. The RC4 remote control is supplied with a 3 metre cable that is used to link with the OPTIONS port on the rear panel of the unit.

### To connect the remote control

- 1 Connect either end of the supplied cable to the socket at the rear of the RC4 remote control.

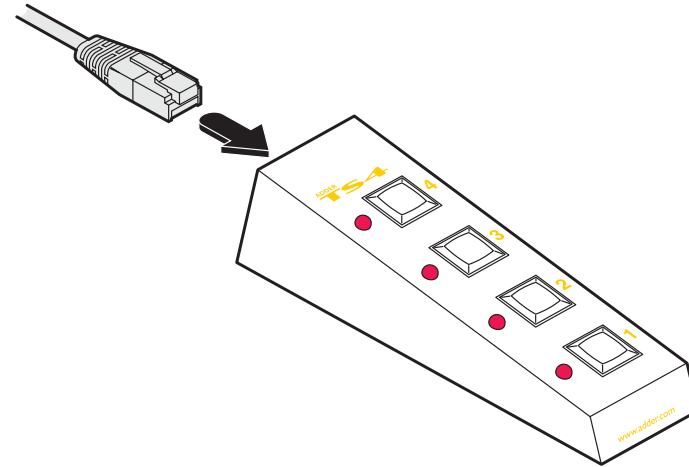

- 2 Connect the other end of the cable to the OPTIONS port on the rear panel of the unit.

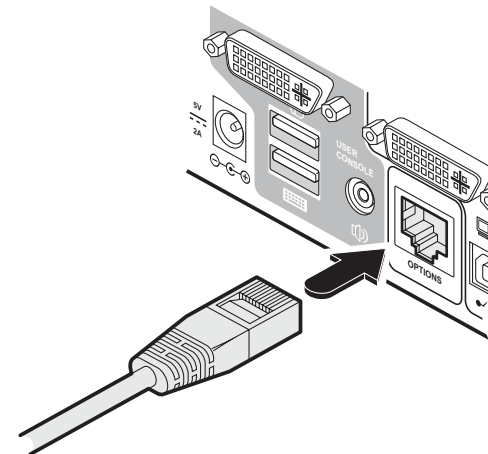

# Channel switching by external control

The OPTIONS port featured on every AV4PRO-DVI allows external control of the current channel either by the optional RC4 controller, commands sent via RS-232 serial input or by switching one of the four channel select input lines. For more details about the necessary RS-232 serial cable, see [Appendix 2](#).

## OPTIONS port pinout

The OPTIONS port can accept either 8p8c or 10p10c connectors, as required.

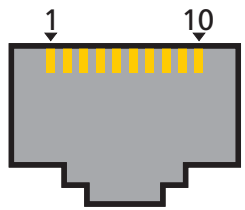
	8p8c	10p10c	Signal
			
		1	Channel select input 1
	1	2	5VDC power output (100mA max)
	2	3	GND reference for all signals
	3	4	RS232 (RXD) data receive
	4	5	RS232 auxiliary data transmit (reserved)
	5	6	RS232 auxiliary data receive (reserved)
	6	7	RS232 (TXD) data transmit
	7	8	Channel select input 2
	8	9	Channel select input 3
		10	Channel select input 4

### To connect a computer or device for remote control

- 1 Insert the 8p8c or 10p10c connector of the cable to the OPTIONS port on the rear panel of the unit.

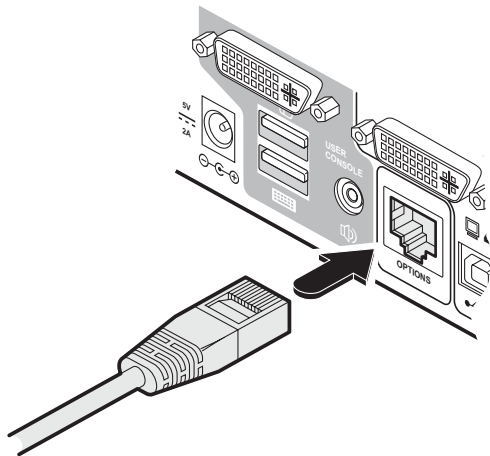

- 2 Connect the other end of the cable to a vacant serial port on the computer or to the output of the switching device.

## Control by RS-232 serial

Where the external control is via RS-232 signal, ensure that the configuration menu option **[O]** is set to **[1]** or **[3]** to enable RS-232 control.

### Serial port parameter settings

Ensure that the chosen serial port is configured to the following:

- Baud rate: To match setting of **[B]** option in the [Configuration menu](#)
- Data bits: 8
- Stop bit: 1
- Parity: None

### Serial port channel selection codes

	ASCII Character	Hex	Decimal
• Channel 1:	'1'	0x31	49
• Channel 2:	'2'	0x32	50
• Channel 3:	'3'	0x33	51
• Channel 4:	'4'	0x34	52

*Note: As each channel is chosen using the above RS-232 commands, the peripherals that will be transferred are determined by the current setting of the switching mode.*

## Control by channel select input lines

Where the external control is via the four channel select input lines of the OPTIONS port (see pin out opposite), ensure that the configuration menu option **[O]** is set to **[3]** to enable the input lines.

The four input lines are suitable for connection to dry contacts or open collector style outputs. Connecting an input line to GND will cause the AV4PRO-DVI to switch all of its functions to the selected channel:

- Channel 1: Channel select input **1** low
- Channel 2: Channel select input **2** low
- Channel 3: Channel select input **3** low
- Channel 4: Channel select input **4** low

If the input line is held low then all other switching requests by other means will be ignored until the line returns to a high (open) state.

If more than one logic input is low (closed) then the lower channel number takes priority.

Note: The input lines have only limited protection against over voltage.

# Synchronising multiple units

AV4PRO-DVI units can be connected together so that they operate in a synchronised manner. Thus, two AV4PRO-DVI units can be made to switch two video heads in a similar manner to an AVPRO-DVI-DUAL. Additionally, two AVPRO-DVI-DUAL units could be made to resemble an AVPRO-DVI-QUAD, while two AVPRO-DVI-QUAD units could be combined in order to switch up to eight video heads simultaneously.

Whenever an AV4PRO-DVI channel is switched, it sends an RS232 command out on its serial interface (marked **OPTIONS** on the rear panel). An AV4PRO-DVI will switch its channel if it receives the same command on its serial interface. Consequently, by linking the serial interfaces, a master unit may be made to automatically switch one or more slave units as shown in the diagram.

It should be noted that the synchronisation cable deliberately does not have the transmit pin of the Slave End connector linked to the receive pin of the Master End connector. To do so would cause the Slave unit to be able to switch the Master unit. This would setup an endless cyclical switching sequence that would prevent the AV4PRO-DVI devices from operating correctly. For more details about the serial synchronisation cables, see [Appendix 2](#).

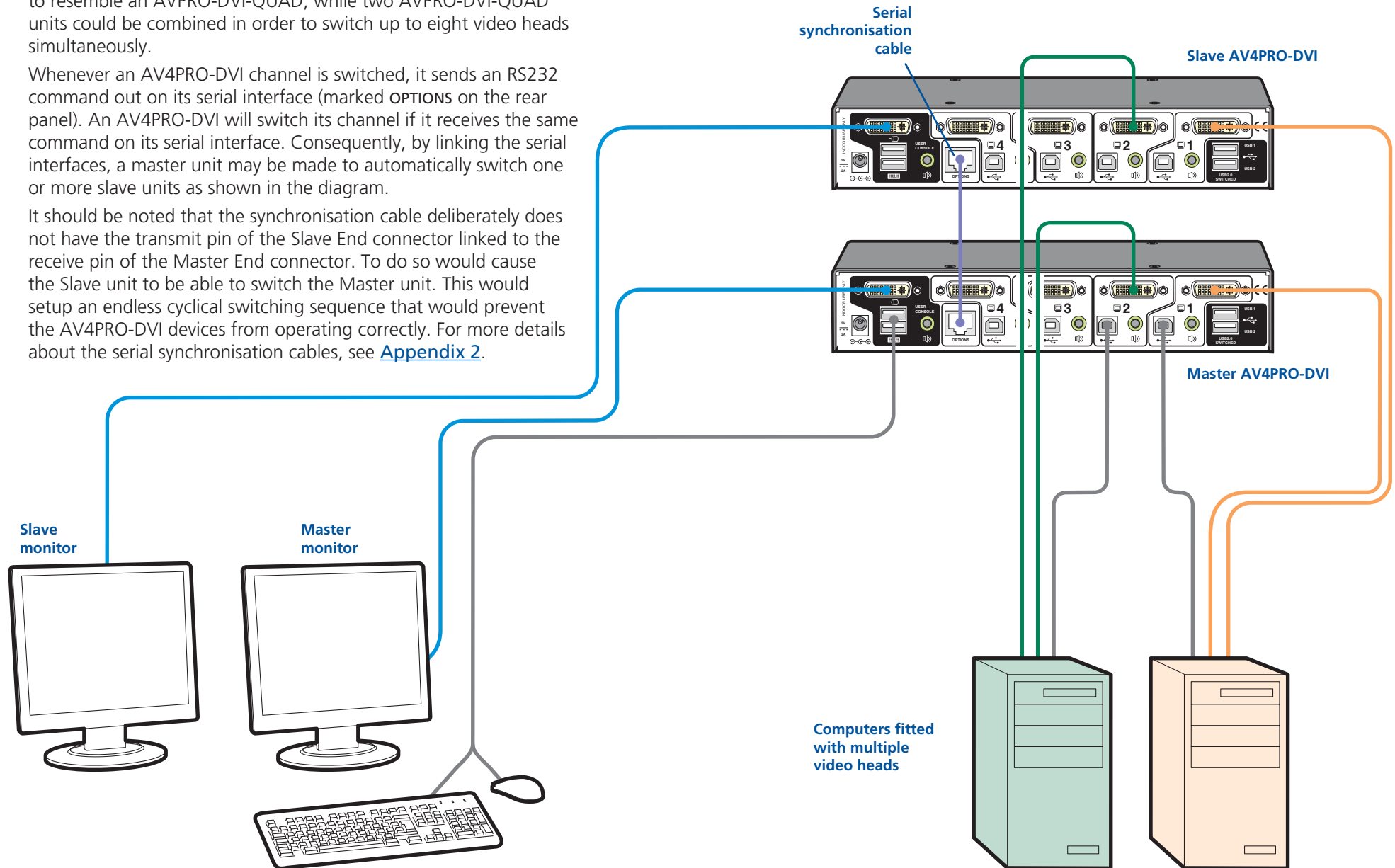

# Managing EDID video display information

Whenever a AV4PRO-DVI unit is powered on (or when the option **F 2** is selected from the [configuration](#) menu), it will interrogate the connected monitor(s) to determine whether EDID (Extended Display Identification Data) information is available. If EDID information is available, it will be copied and used; otherwise a default set of data, stored within the AV4PRO-DVI, will be substituted. You can also optionally choose to prevent the unit from seeking new EDID information and instead rely only on stored data.

## EDID Emulation

The AV4PRO-DVI units use our *EDID Emulation* feature to ensure that the collected EDID information (up to two pages) is correctly supplied to every connected computer, whether it is currently selected or not:

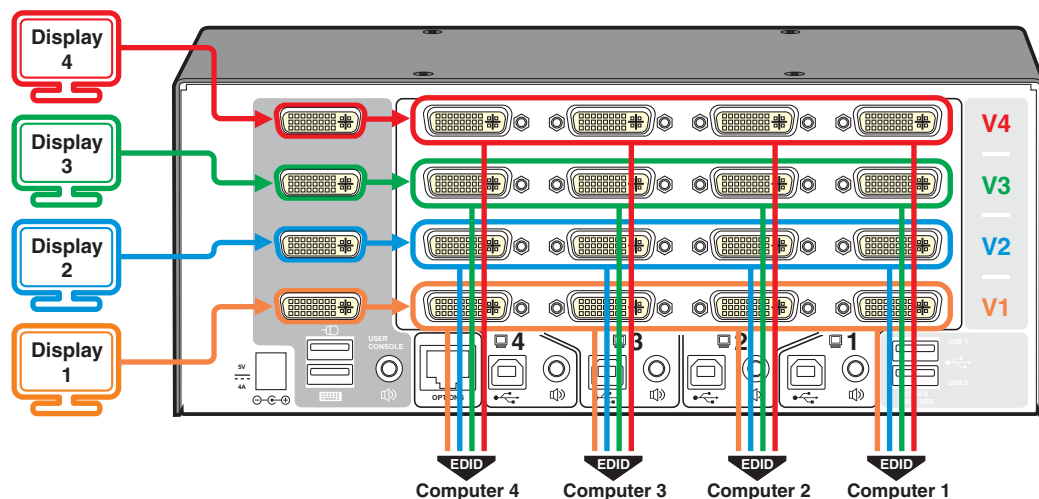

## Hybrid DDC

In addition to EDID Emulation, all AV4PRO-DVI units provide a feature known as Hybrid DDC. This feature supports the industry standard DDC/CI (Command Interface) protocol and allows full two-way communication between the display and the currently selected computer. This allows the computer to make adjustments to the display (e.g. brightness, colour balance, etc.), an important requirement for certain professional applications. Hybrid DDC can also transfer the authorisation signals that are required by HDCP (High-bandwidth Digital Content Protection) compliant video sources and displays that ensure high definition copy protection.

## Refreshing EDID information during use

You can refresh the EDID information from the connected monitor(s) without the need to power cycle the AV4PRO-DVI.

### To refresh EDID information during use

- 1 Enter the [Configuration](#) menu.
- 2 Press **F** to enter the **Functions** menu
- 3 Press **2** and then **Enter**.
- 4 Press **E** and then **Enter** to exit the menu.

## Using stored EDID information only

You can choose to prevent the unit from interrogating the video display(s) during startup. When you invoke this option, the unit will only use the EDID information that it has already stored and pass this on to the connected computers. To revert to interrogating the video display, use the F 2 function discussed above.

### To use the stored EDID information at the power up

- 1 Enter the [Configuration](#) menu.
- 2 Press **F** to enter the **Functions** menu
- 3 Press **3** and then **Enter**.
- 4 Press **E** and then **Enter** to exit the menu.

## Hybrid DDC (support for DDC/CI)

The Hybrid DDC feature supports the industry standard DDC/CI (Command Interface) protocol and allows full two-way communication between the display and the currently selected computer. You can enable or disable the Hybrid DDC feature as required.

### To enable/disable Hybrid DDC feature

- 1 Enter the [Configuration](#) menu.
- 2 Press **U** to enter the **User Preferences** menu and then press either:
  - 9** to **Enable Hybrid DDC**
  - 0** to **Disable Hybrid DDC**
- 3 Press **Enter** to accept the setting and return to the main menu section.
- 4 Press **E** and then **Enter** to exit the menu and save changes.



INSTALLATION

CONFIGURATION

OPERATION

FURTHER INFORMATION

INDEX

# Configuration

## Using the configuration menu

The configuration mode allows you to determine numerous aspects of the AV4PRO-DVI unit capabilities.

### To use the configuration menu

During normal use, the seven segment display on the front panel shows the number of the currently selected computer channel. From this condition, enter configuration mode as follows:

- 1 Press and hold the front panel **COMPUTER** button for roughly five seconds.

The display will show: **[**

- 2 On the keyboard, press the letter key for the required menu section, e.g. **[S]**

The display will show the pressed letter, e.g. **5**

- 3 Press the number of the required setting, e.g. **[4]**

The display will show the pressed number, e.g. **4**

- 4 Press **[Enter]** to accept the setting and return to the main menu section.

The display will show: **[**

- 5 You can now continue with your next configuration change (go to step 2), or exit from the configuration menu (see below).

### To exit the configuration menu and save changes

- Press **[E]** and then press **[Enter]** to exit and save changes.

### To exit the configuration menu without saving

- Press either of the front panel buttons.

- [B]** Enter the **OPTIONS** port **Baud rate** menu

- |  |                   |
|--|-------------------|
| <b>[1]</b> 1200 <small>(default)</small> | <b>[5]</b> 38400  |
| <b>[2]</b> 2400                          | <b>[6]</b> 57600  |
| <b>[3]</b> 9600                          | <b>[7]</b> 115200 |
| <b>[4]</b> 19200                         |                   |

You can press **[Esc]** at any point to exit from an option and return to the main menu (**[**) section.

- [F]** Enter the **Functions** menu

- |   |
|---|
| <b>[1]</b> Show current firmware version  |
| <b>[2]</b> Refresh EDID information from the connected video display <small>(default)</small> |
| <b>[3]</b> Use the stored EDID at startup, do not interrogate the video display               |
| <b>[8]</b> Reset configuration to factory defaults ( <b>r</b> is displayed momentarily)       |

- [H]** Enter the **Hotkey** menu

- |  |                             |
|--|-----------------------------|
| <b>[1]</b> Ctrl + Alt <small>(default)</small> | <b>[5]</b> Alt              |
| <b>[2]</b> Ctrl + Shift                        | <b>[6]</b> Left Ctrl + Alt  |
| <b>[3]</b> Alt + Shift                         | <b>[7]</b> Right Ctrl + Alt |
| <b>[4]</b> Right Alt                           | <b>[8]</b> Hotkeys disabled |

- [O]** Enter the **Options port** behaviour menu

- |   |
|---|
| <b>[1]</b> Channel switching via RS-232 serial control (using the baud rate set by the 'B' option). Contact switching via the Options port disabled. <small>(d)</small> |
| <b>[2]</b> Channel switching via RC4 remote. Contact switching disabled.  |
| <b>[3]</b> As per <b>[1]</b> but with contact switching enabled.  |

- [P]** Set a new password for use with the lock mode

- [S]** Enter the **Switch Mode** menu

- |   |
|---|
| <b>[1]</b> All <small>(default)</small> |
| <b>[2]</b> KVM + Speaker                |
| <b>[3]</b> KVM only                     |
| <b>[4]</b> Speaker only                 |
| <b>[5]</b> USB1 only                    |
| <b>[6]</b> USB2 only                    |

(default) or (d) denote the default settings for each group of options.

- [T]** Enter the **Autoscan Time Delay** menu

- |   |                       |
|---|-----------------------|
| <b>[1]</b> Autoscan disabled                  | <b>[5]</b> 15 seconds |
| <b>[2]</b> 2 seconds                          | <b>[6]</b> 30 seconds |
| <b>[3]</b> 5 seconds <small>(default)</small> | <b>[7]</b> 1 minute   |
| <b>[4]</b> 7 seconds                          | <b>[8]</b> 5 minutes  |

- [U]** Enter the **User Preferences** menu

- |   |
|---|
| <b>[1]</b> Enable mouse switching <small>(default)</small>                                    |
| <b>[2]</b> Disable mouse switching  |
| <b>[7]</b> Cycle all ports (when using 'Hotkey + Tab' or 'Autoscan') <small>(default)</small> |
| <b>[8]</b> Cycle only active ports (when using 'Hotkey + Tab' or 'Autoscan')                  |
| <b>[9]</b> Enable Hybrid DDC mode (provides support for DDC/CI)                               |
| <b>[0]</b> Disable Hybrid DDC mode <small>(default)</small>                                   |



# General configuration

## Changing hotkeys

AV4PRO-DVI units use **Ctrl** and **Alt** as their standard hotkeys. These can be changed if they clash with other software or hardware within the installation.

### To change the hotkeys

- 1 Enter the [Configuration](#) menu.
- 2 Press **H** to enter the **Hotkey** menu and then press either:
  - 1** to choose **Ctrl + Alt**
  - 2** to choose **Ctrl + Shift**
  - 3** to choose **Alt + Shift**
  - 4** to choose **Right Alt**
  - 5** to choose **Alt**
  - 6** to choose **Left Ctrl + Alt**
  - 7** to choose **Right Ctrl + Alt**
  - 8** to disable the Hotkeys
- 3 Press **Enter** to accept the setting and return to the main menu section.
- 4 Press **E** and then **Enter** to exit the menu and save changes.

## Mouse switching

You can enable or disable mouse switching to suit your installation requirements.

### To enable/disable mouse switching

- 1 Enter the [Configuration](#) menu.
- 2 Press **U** to enter the **User Preferences** menu and then press either:
  - 1** to **Enable mouse switching**
  - 2** to **Disable mouse switching**
- 3 Press **Enter** to accept the setting and return to the main menu section.
- 4 Press **E** and then **Enter** to exit the menu and save changes.

## OPTIONS port speed

You can change the speed of the OPTIONS serial port.

### To change the OPTIONS port speed

- 1 Enter the [Configuration](#) menu.
- 2 Press **B** to enter the **Baud rate** menu and then press either:
  - 1** to choose **1200**
  - 2** to choose **2400**
  - 3** to choose **9600**
  - 4** to choose **19200**
  - 5** to choose **38400**
  - 6** to choose **57600**
  - 7** to choose **115200**
- 3 Press **Enter** to accept the setting and return to the main menu section.
- 4 Press **E** and then **Enter** to exit the menu and save changes.

## OPTIONS port channel control behaviour

You can determine how the OPTIONS port responds to channel control inputs.

### To define the OPTIONS port behaviour

- 1 Enter the [Configuration](#) menu.
- 2 Press **O** to enter the **Options port** menu and then press either:
  - 1** to allow channel switching commands to be received via RS-232 serial signal through the OPTIONS port (see [Appendix 2](#) for cable pin-out details and [Channel switching by external control](#) for command details). The baud rate currently set by the **B** option will be used for the port. Switching commands via the four channel select inputs within the OPTIONS port connector are disabled in this mode. Use option **3** if you wish to enable the channel select inputs in addition to RS-232 control.
  - 2** to allow channel switching commands to be received from the optional RC4 remote control (see [Optional RC4 control](#) for connection details). The baud rate set by the **B** option is ignored and the rate used by the RC4 is automatically imposed. Switching commands via the four channel select inputs within the OPTIONS port connector are disabled in this mode.
  - 3** enables channel switching via RS-232 as per option **1**. However, in this mode the four channel select inputs are also enabled.
- 3 Press **Enter** to accept the setting and return to the main menu section.
- 4 Press **E** and then **Enter** to exit the menu and save changes.

*continued*



## Switching mode

Using the configuration menu, you can define a default switching mode. The switching mode determines which peripherals (KVM, USB1, USB2 and/or speakers) should be moved to the next computer when it is selected using any of the standard methods. Regardless of the default switching mode set here, during use you can always change the mode using either the MODE button (on the front panel) or using the additional hotkey press combinations.

*Note: Of the external switching methods, the RC4 remote and the RS-232 serial signal inputs will switch the peripherals as defined by the currently selected switching mode. However, switching control initiated by the channel select input lines will always switch all of the peripherals to the chosen channel regardless of the switching mode.*

### To set the default switching mode

- 1 Enter the [Configuration](#) menu.
- 2 Press **[S]** to enter the **Switch Mode** menu and then press either:
  - [1]** to select **All** (default)
  - [2]** to select **KVM and speaker**
  - [3]** to select **KVM only**
  - [4]** to select **Speaker only**
  - [5]** to select **USB1 only**
  - [6]** to select **USB2 only**
- 3 Press **[Enter]** to accept the setting and return to the main menu section.
- 4 Press **[E]** and then **[Enter]** to exit the menu and save changes.

## Miscellaneous functions

### To refresh EDID information from the monitor

- 1 Enter the [Configuration](#) menu.
- 2 Press **[F]** to enter the **Functions** menu
- 3 Press **[2]** and then **[Enter]**.
- 4 Press **[E]** and then **[Enter]** to exit the menu and save changes.

### To use the stored EDID information at the power up

When you engage this mode, the unit will not interrogate the video display during startup and will instead use the data that are stored. To revert to interrogating the video display, use the F 2 function discussed above.

- 1 Enter the [Configuration](#) menu.
- 2 Press **[F]** to enter the **Functions** menu
- 3 Press **[3]** and then **[Enter]**.
- 4 Press **[E]** and then **[Enter]** to exit the menu and save changes.

### To reset configuration to factory defaults

- 1 Enter the [Configuration](#) menu.
- 2 Press **[F]** to enter the **Functions** menu
- 3 Press **[8]** and then **[Enter]**. The display will show **r** momentarily.
- 4 Press **[E]** and then **[Enter]** to exit the menu and save changes.

### To show the current firmware version

- 1 Enter the [Configuration](#) menu.
- 2 Press **[F]** to enter the **Functions** menu
- 3 Press **[1]** and then **[Enter]**.

The display will blank for a short while and then the major number of the firmware revision will be shown. The display will blank again and then show the first digit of the minor number. Following another blank, the second digit of the minor number will be displayed. e.g. <blank> 1 <blank> 0 <blank> 2 <blank> equals v1.02
- 4 Press **[E]** and then **[Enter]** to exit the menu and save changes.

### To set a new password

- 1 Enter the [Configuration](#) menu.
- 2 Press **[P]** and then **[Enter]**. The display will show **:**
- 3 Enter a new password and then **[Enter]**. See [To lock access to the computers](#).
- 4 Press **[E]** and then **[Enter]** to exit the menu and save changes.





# Performing upgrades

The AV4PRO-DVI unit is fully upgradeable via flash upgrade. Such upgrades require a Windows-based computer system to be linked via the **OPTIONS** port.

## Items required to perform an upgrade

- Optional upgrade cable (VSC40) - see [Appendix 2](#) for pin-out specifications.
- A Windows-based upgrade computer with an RS232 serial port.
- The latest version of the KVM Firmware Uploader and firmware files for the AV4PRO-DVI unit - available from the *Technical Support > Updates* section of the Adder Technology website ([www.adder.com](http://www.adder.com)).

## To use the KVM Firmware Uploader utility

### 1 - Obtain and run the KVM Firmware Uploader.

Download the latest AV4PRO-DVI unit KVM Firmware Uploader from the Adder Technology website and install it on a Windows-based upgrade computer that will be connected to the AV4PRO-DVI unit. The files are supplied as a compressed ZIP file. Decompress the ZIP file with an appropriate tool such as WinZip ([www.winzip.com](http://www.winzip.com)) and copy all contained files to the same folder on the upgrade computer.

### 2 - Power off the AV4PRO-DVI unit

Remove the power supply plug from the rear panel of the unit.

### 3 - Connect the upgrade computer to the AV4PRO-DVI unit

Connect the serial port of the upgrade computer to the **OPTIONS** port on the rear panel of the unit using the optional upgrade cable.

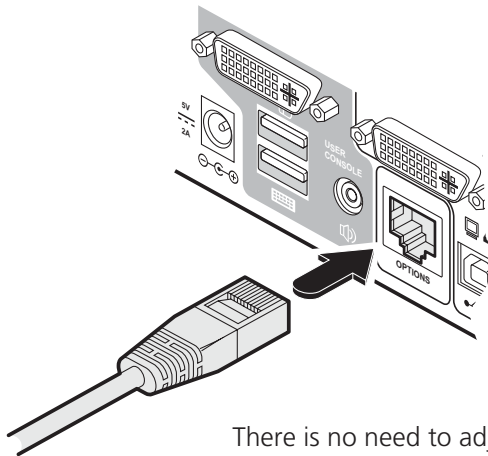

There is no need to adjust the computer's serial port settings as the application will do this automatically.

### 4 - Invoke upgrade mode

While powering on or when already powered: Press and hold the **COMPUTER** and **MODE** buttons (for up to ten seconds) until the numeric indicator shows '**U**'.

### 5 - Run the KVM Firmware Uploader utility

From that folder, select the KVMUploader icon to run the upgrade utility. The KVM Firmware Uploader dialog will be displayed:

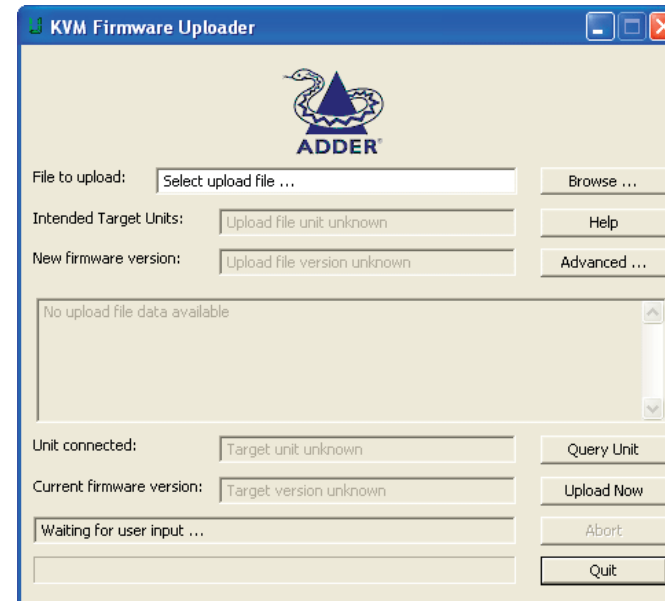

### 6 - Query the AV4PRO-DVI unit

Click the *Query Unit* button to confirm that communication is possible with the AV4PRO-DVI unit and to establish its firmware details. If successful, the 'Unit connected' field should show the name of the AV4PRO-DVI unit and the current firmware will also be listed.

If the application cannot contact the AV4PRO-DVI unit, re-check the connection cable and click the *Advanced...* button to check that the correct serial port is being used. Change the serial port within the *Advanced...* section, if necessary.

*continued*



### 7 - Select the upgrade file to be used

From the main KVM Firmware Uploader dialog, click the *Browse...* button and select the upgrade file:

AV4Pro\_xxx.txt

where xxx is the firmware version.

The upgrade file details will be displayed within the dialog.

**IMPORTANT:** Check that the 'Intended Target Units' field matches the 'Unit Connected' field. If these fields do not match then you may have an incorrect upgrade file, check with Adder Technology Ltd before proceeding. Check also that the 'New firmware version' is greater than the 'Current firmware version'.

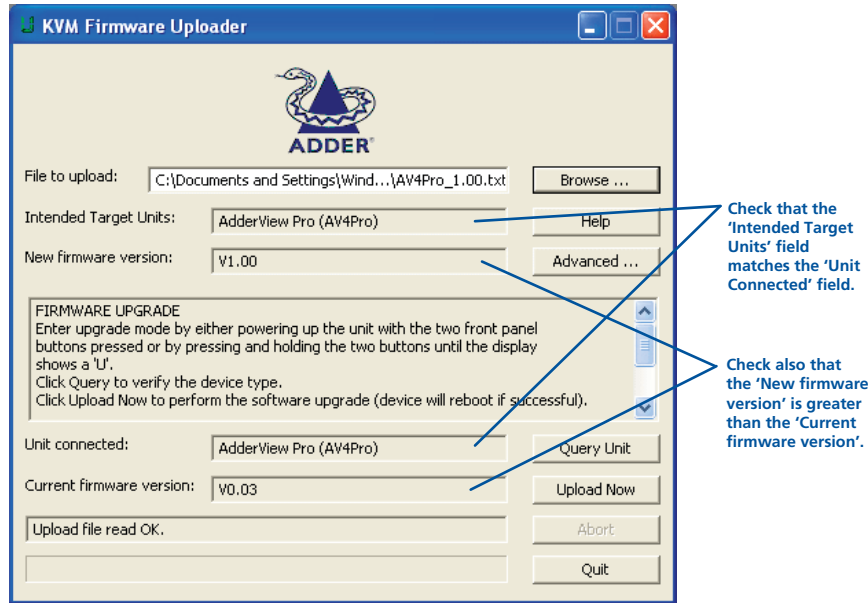

### Issues to consider when performing flash upgrades

The upgrade program rewrites the internal firmware code. If the upgrade process is interrupted then the unit will have invalid code and will not be able to operate. It is therefore good practice to ensure that the upgrade process is always fully completed. A partial or failed upgrade may be rectified by performing another upgrade.

**WARNING:** Running faulty or partially upgraded code may have unpredictable results and may damage your AV4PRO-DVI unit or computing equipment.

### 8 - Commence the upgrade

To begin the upgrade process, click the *Upload Now* button. The progress will be shown within the dialog. Should you decide not to continue with the upload at any stage, click the *Abort* button; response to this is usually immediate, however, during an erase command, the upload will not be aborted until the erase is complete (this may take a few seconds).

### 9 - Cycle the power

Disconnect the power. When the power is re-applied the AV4PRO-DVI unit will operate using the new firmware.

# Operation

## Selecting a computer

There are four main ways to switch the common peripherals to specific computer channels:

- Using the front panel controls ➡
- [Using hotkeys](#)
- [Using mouse button presses](#)
- Using external switching control ([RC4 remote](#), [RS-232](#) or [input lines](#))

## To select a computer using the front panel

The front panel allows you to determine how the various peripherals are switched to one or more computer channels.

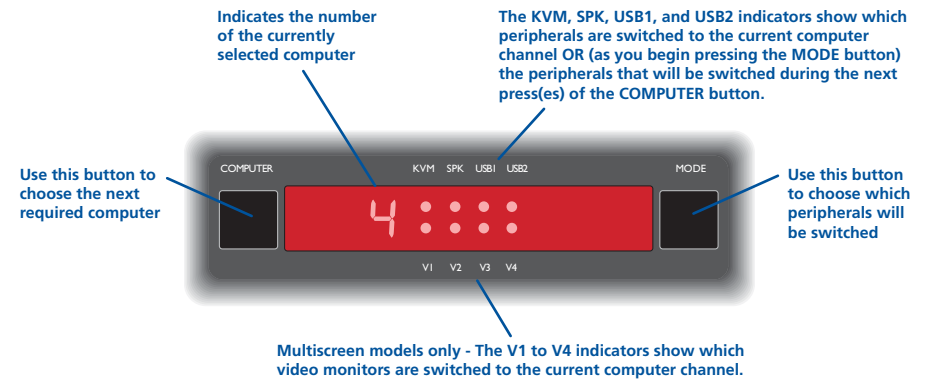

- 1 Optional: If you need to selectively switch some of your peripherals, press the MODE button repeatedly to change the switching mode:

	KVM	SPK	USB1	USB2	
MODE →	●	●	●	●	Will switch all peripherals together
MODE →	●	●	●	●	Will switch keyboard, video, mouse and speakers
MODE →	●	●	●	●	Will switch only the keyboard, video and mouse
MODE →	●	●	●	●	Will switch only the speakers
MODE →	●	●	●	●	Will switch only USB peripheral 1
MODE →	●	●	●	●	Will switch only USB peripheral 2

- Note: If an indicator flashes, it signifies that the respective peripheral is currently switched to another computer channel.*
- 2 Press the COMPUTER button repeatedly to select the required computer channel.

## To select a computer using hotkeys

Using hotkey combinations, you can quickly switch the keyboard, video monitor(s), mouse and speakers and USB peripherals to any computer channel.

There are two main ways to use hotkeys: *Standard* and *Additional*.

### Standard hotkey press combinations

The standard hotkey press combinations allow you to change channels with the minimum of keypresses:

- 1 Simultaneously press and hold **Ctrl** and **Alt** (or other hotkeys, if altered).
- 2 While still holding **Ctrl** and **Alt**, press the number key of the required channel address (or the TAB key), then release all of the keys.

*Note: The numbers on your keyboard's numeric keypad are not valid, use only the numeral keys above the QWERTY section.*

The ports (KVM, audio and/or USB) that are switched using this method depend upon the switching mode that is currently set using the [front panel buttons](#).

The range of standard hotkey combinations are as follows:

*Note: If your hotkeys have been changed, substitute them for **Ctrl** and **Alt** in the examples given here.*

<b>Ctrl</b> <b>Alt</b> <b>1</b>	Selects channel 1
<b>Ctrl</b> <b>Alt</b> <b>2</b>	Selects channel 2
<b>Ctrl</b> <b>Alt</b> <b>3</b>	Selects channel 3
<b>Ctrl</b> <b>Alt</b> <b>4</b>	Selects channel 4
<b>Ctrl</b> <b>Alt</b> <b>0</b>	Isolates the user console from all channels
<b>Ctrl</b> <b>Alt</b> <b>Tab</b>	Selects the next channel (see note ⇔)

### What are hotkeys?

The **Ctrl** and **Alt** keys when pressed in combination are called 'hotkeys' and they signal to the AV4PRO-DVI unit that you wish to control it, rather than the computer. However, if these particular hotkeys clash with another device or program, you can change them to a different combination within the [Configuration](#) menu.

### Additional hotkey press combinations

In addition to the standard hotkey press combinations (shown left), you can also add additional keypresses in order to determine which peripherals are switched:

- 1 Simultaneously press and hold **Ctrl** and **Alt**.
- 2 Press and release a command key:
  - A** to switch all peripherals
  - K** to switch only the keyboard, video and mouse
  - S** to switch only the speakers
  - U** to switch only USB1 and USB2
- 3 Press and release the required channel number (**1** to **4** using only the keys above the QWERTY section).
- 4 Release **Ctrl** and **Alt**.

The appropriate peripherals will change to the chosen channel.

*Note: Regardless of which peripherals were switched, the front panel indicators will continue to show the switching mode that was last determined using the front panel controls.*

### Choosing which computers are accessed when using hot keys + tab

The computer channels that are visited when you use the hot keys + tab (or mouse buttons/autoscan) are determined by a setting within the Configuration menu:

- 1 Enter the [Configuration](#) menu.
- 2 Press **U** and then press either:
  - 7** to choose **Cycle all ports**, or
  - 8** to choose **Cycle only active ports**
- 3 Press **Enter** to accept the setting and return to the main menu section.
- 4 Press **E** and then **Enter** to exit the menu and save changes.

## To select a computer using the mouse buttons

Using the mouse buttons, you can quickly switch the keyboard, mouse, video monitor(s), speakers and/or USB peripherals to any computer channel.

*Note: These procedures work only with three-button or IntelliMouse devices and only if the 'Mouse Switching' option has been enabled.*

### To select a computer using the mouse buttons

- 1 Hold down the middle button (or scroll wheel) of the mouse.
- 2 Click the left mouse button to increment the channel number or click the right mouse button to decrement the channel. When the correct channel is reached, release the middle button.

When using this method of switching:

- The computer channels that are visited depend upon the configuration menu setting (see note ⇔).
- The ports (KVM, audio and/or USB) that are switched using this method depend upon the switching mode that is currently set using the [front panel buttons](#).

### Choosing which computers are accessed when using mouse buttons

The computer channels that are visited when you use the mouse buttons (or hotkeys + tab/autoscan) are determined by a setting within the Configuration menu:

- 1 Enter the [Configuration](#) menu.
- 2 Press **U** and then press either:
  - 7** to choose **Cycle all ports**, or
  - 8** to choose **Cycle only active ports**
- 3 Press **Enter** to accept the setting and return to the main menu section.
- 4 Press **E** and then **Enter** to exit the menu and save changes.

## To lock access to the computers

When privacy is required, you can lock access to the connected computers via the unit.

### To lock the unit

- 1 Simultaneously press and hold **Ctrl** and **Alt** (or other hotkeys, if altered).
- 2 While still holding **Ctrl** and **Alt**, press **L**.  
The display will show **P** (providing a valid password has been previously set). You will not be able to access any computers until the password is correctly entered.

### To unlock the unit

- When prompted, enter the correct password and press **Enter**.

### To set a new password

- 1 Enter the [Configuration](#) menu.
- 2 Press **P** and then **Enter**. The display will show **:**
- 3 Enter a new password and then **Enter**.  
The password is not case sensitive and can be any combination of key strokes, including the function keys, but excluding the Num Lock, Caps Lock, Scroll Lock and **Enter** keys. If your keyboard has special media keys, these also cannot be used as part of the password.  
When you have typed in your password, press **Enter** to store it. Don't worry if you type the password incorrectly, you can always re-enter configure mode and set the password again.
- 4 Press **E** and then **Enter** to exit the menu and save changes.

### To cancel the password

- 1 Enter the [Configuration](#) menu.
- 2 Press **P** and then **Enter**. The display will show **:**
- 3 Press **Enter** to remove the existing password.
- 4 Press **E** and then **Enter** to exit the menu and save changes.

### If you forget the password

To clear an existing password: Connect the OPTIONS port of the unit to the serial port of a computer and transmit the text **clrpwd** to the unit.

# Autoscanning

When enabled, the autoscanner mode switches between the connected computers in sequence. This is useful to allow you to sample activity among the connected computers.

Two scanning modes are available:

- *Cycle all ports* – This mode visits, in turn, to each connected computer. This mode should be used with care due to the reasons given in the warning below. To prepare for this autoscanner mode, choose **U 7** within the configuration menu (see right).
- *Cycle only active ports* – Only computer ports where an active computer is detected will be viewed. This mode avoids blank screens from being displayed and helps to prevent the viewing monitor from entering a power-down state on every scan cycle.

Additionally, when this mode is selected, whenever you use either the mouse buttons or hot keys + tab to change channels, only computers that are active will be visited. To prepare for this autoscanner mode, choose **U 8** within the configuration menu (see right).

**WARNING:** Many monitors are fitted with automatic power saving relays that switch off after a few seconds when connected to an inactive computer. If you are using such a monitor, do not use the 'Cycle all ports' mode. Continual switching on and off of the monitor's relay will eventually damage the monitor.

Seven autoscanner periods are available (the time spent viewing each computer) ranging from 2 seconds to 5 minutes. To prepare the autoscanner period, choose **T** and then **2** to **8** within the configuration menu (see right).

To start autoscanning mode, press **Ctrl Alt X** on the keyboard.

## To select an autoscanner mode

- 1 Enter the [Configuration](#) menu.
- 2 Press **U** and then press either:
  - **7** to choose **Cycle all ports**, or
  - **8** to choose **Cycle only active ports**
- 3 Press **Enter** to accept the setting and return to the main menu section.
- 4 Press **E** and then **Enter** to exit the menu and save changes.

*Note: The setting of this option also affects which computers are visited when the channel is changed using the mouse buttons or hot key + tab.*

## To select an autoscanner period

- 1 Enter the [Configuration](#) menu.
- 2 Press **T** and then press either:
  - 1** to choose **Autoscanner disabled**,
  - 2** to choose **2 seconds**,
  - 3** to choose **5 seconds**,
  - 4** to choose **7 seconds**,
  - 5** to choose **15 seconds**,
  - 6** to choose **30 seconds**,
  - 7** to choose **1 minute**, or
  - 8** to choose **5 minutes**.
- 3 Press **Enter** to accept the setting and return to the main menu section.
- 4 Press **E** and then **Enter** to exit the menu and save changes.

## To start autoscanning

- On the keyboard, press **Ctrl Alt X**.

Notes:

*During autoscanning, mouse switching, hot key + tab and interactivity with the computers are all disabled.*

*During autoscanning, only the KVM and speaker ports are switched to each visited computer channel, the two USB device ports remain connected to their currently selected channels.*

## To stop autoscanning

You can stop the autoscanning process in either of the following ways:

- Press the **COMPUTER** button on the front panel, or
- Select a specific channel using the hot keys + channel number.



# Further information

This chapter contains a variety of information, including the following:

- Getting assistance - see right
- [Appendix 1 – Supported video modes](#)
- [Appendix 2 – Cable pin-outs](#)

## Getting assistance

If you are still experiencing problems after checking the information contained within this guide, then please refer to the Support section of our website:

[www.adder.com](http://www.adder.com)



INSTALLATION

CONFIGURATION

OPERATION

FURTHER  
INFORMATION

INDEX



## Appendix 1 – Default EDID video modes

The following digital video modes are defined within the default EDID information held by the AV4PRO-DVI units. This information is used only if no new EDID information is made available by the attached video monitor(s). The AV4PRO-DVI units support video resolutions and refresh rates in excess of those listed here.

1024 x 768p at 60Hz	Native/preferred timing
720 x 400p at 70Hz	IBM VGA
720 x 400p at 88Hz	IBM XGA2
640 x 480p at 60Hz	IBM VGA
640 x 480p at 67Hz	Apple Mac II
640 x 480p at 72Hz	VESA
640 x 480p at 75Hz	VESA
800 x 600p at 56Hz	VESA
800 x 600p at 60Hz	VESA
800 x 600p at 72Hz	VESA
800 x 600p at 75Hz	VESA
832 x 624p at 75Hz	Apple Mac II
1024 x 768i at 87Hz	IBM
1024 x 768p at 60Hz	VESA
1024 x 768p at 70Hz	VESA
1024 x 768p at 75Hz	VESA
1280 x 1024p at 75Hz	VESA
1152 x 870p at 75Hz	Apple Mac II
1600 x 1200p at 60Hz	VESA STD
1680 x 1050p at 60Hz	VESA STD
1360 x 765p at 60Hz	VESA STD
1360 x 768p at 60Hz	
1440 x 900p at 60Hz	VESA STD
1280 x 720p at 60Hz	VESA STD
1920 x 1080p at 60Hz	VESA STD



INSTALLATION

CONFIGURATION

OPERATION

FURTHER  
INFORMATION

INDEX

## Appendix 2 – Cable pin-outs

The OPTIONS port uses a 10p10c socket which can accommodate both 10p10c connectors as well as the much more common 8p8c connectors, which are used on Ethernet leads and patch cables. The pin-outs are listed in this section for both types of connector.

### Serial remote control and flash upgrade cable (8p8c)

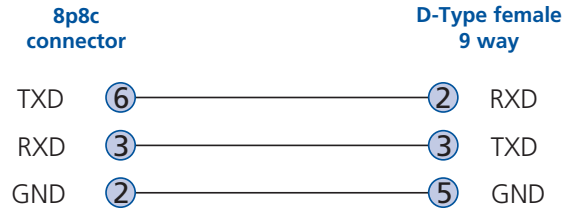

### Serial remote control and flash upgrade cable (10p10c)

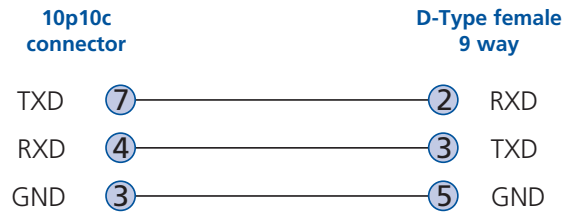

### Multi-head synchronisation cable (8p8c)

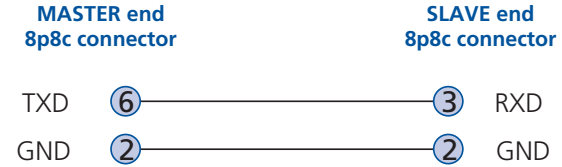

### Multi-head synchronisation cable (10p10c)

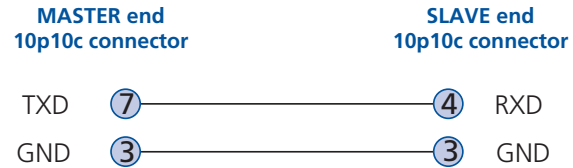

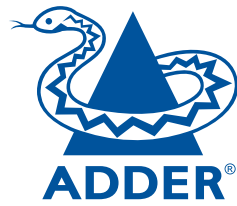

[www.adder.com](http://www.adder.com)

INSTALLATION

CONFIGURATION

OPERATION

**FURTHER  
INFORMATION**

INDEX

# Index



## A

Audio  
  connection 7  
Autoscanning 22

## B

Brackets  
  fitting 6

## C

Cable pin-outs 25  
Channel select input lines 10  
Channel selection codes 10  
Computer  
  connection 8  
  ports 4  
  selecting 18  
Configuration 13  
Connections 7  
  computer system 8  
  multiple video heads 11  
  user console 7

## D

DDC/CI 12

## E

EDID information 12  
  default video modes 24  
Emulated switching 3  
Enumerated switching 3  
External control 10

## F

Firmware  
  upgrade 16  
Front panel  
  switching 18

## H

Host computer  
  connection 8  
Hotkeys  
  changing 14  
  selecting computers 19  
  what are they? 19  
Hybrid DDC 12

## I

Indicators 4

## K

Keyboard  
  connection 7  
KVM 2

## L

Lock the unit 21

## M

Mounting 6  
Mouse  
  connection 7  
Multiple units  
  synchronising 11  
Multiple video head  
  connections 11

## O

Operation 18  
Options port 4  
  behaviour setting 14  
  pinout 10  
  speed setting 14

## P

Parts  
  supplied and extra 5  
Password  
  setting & entering 21  
Peripherals  
  connecting 7

## R

Rack mounting 6  
Remote control  
  by computer 10,14  
  by RC4 unit 9  
Remote wakeup 2  
RS-232 serial  
  switching commands 10

## S

Selecting computers  
  with front panel 18  
  with hotkeys 19  
  with mouse buttons 20  
Serial port  
  settings for control 10  
Speakers  
  connection 7  
Supplied items 5  
Switching 18  
  by input lines 10  
  by RS-232 serial 10  
Switching mode  
  setting a default 15

## T

Troubleshooting 23  
True Emulation 2,3

## U

Unlock the unit 21  
Upgrade  
  firmware 16  
USB device  
  connection 7  
USB Remote wakeup 2  
USB switching  
  emulation 3  
  enumeration 3  
  True Emulation 2,3  
User console 4

## V

Video modes 24  
Video port  
  connection 7

INSTALLATION

CONFIGURATION

OPERATION

FURTHER  
INFORMATION

INDEX